

Unite CDD-8/4

Cockpit Desktop Charger

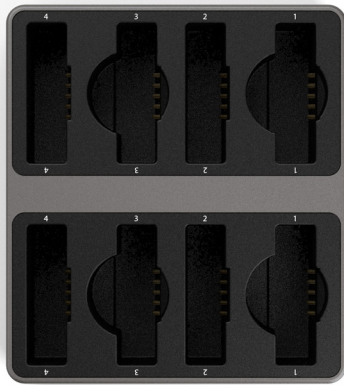

CONFERENCE

Description

The Unite CDD-8/4 is a multifunctional device, which is used to charge the batteries integrated in the Unite transmitters and receivers as well as to store and transmit the pairing information (channel name and group ID) from the transmitter to the receiver. For optimal security against unauthorised listening, an audio encryption key will be generated inside the Unite CDD-8/4 and transmitted to the transmitters and receivers during the pairing process.

The Unite CDD-8/4 can be integrated into a network by using the Ethernet connection. With the Unite Manager software the desktop charger can be monitored remotely. Furthermore, firmware updates and configurations can be carried out via this software.

The desktop charger can be attached to a table top via two holes at the bottom.

The Unite CDD-8/4 desktop charger provides a maximum of eight charging compartments, four of them are compatible with the Unite TH handheld transmitter. The charging state of the batteries is displayed via the status indicator on the appropriate transmitter or receiver.

Features

- » Desktop charger for Unite transmitters and receivers with eight charging compartments – four of them are compatible with the Unite TH handheld transmitter
- » Buttons for pairing process
- » Status indicator for pairing process
- » Separate power indicator
- » Reset button

- » Ethernet connection for:
 - Firmware update
 - Pairing
 - Maintenance and monitoring
- » USB connection for:
 - Pairing
 - Charging
- » 12 V DC connection for power supply unit

Version

Unite CDD-8/4 - Ref. 71.98.4044:

- » Cockpit desktop charger for a maximum of 8 Unite bodypack transmitters / receivers.
- » Four of the eight charging compartments are compatible with the Unite TH handheld transmitter. Network connection, USB-C connection, incl. power supply unit

Supplied Accessories

- » XP Power VEC50US12 power supply unit

Specifications

Power Supply Unit XP Power VEC50US12 for Unite CDD-8/4	
AC input	90 - 264 V, 47 - 63 Hz
Nominal current	1 A @ 115 V AC, 0.7 @ 230 V AC
Power consumption	50 W with 8 charging compartments
Output voltage	12 V DC, 4.17 A
Charger	
Max. charging time	Approx. 4 hrs.
Connections	Ethernet USB Typ C (USB 2.0, 0.5 A)
Temperature range:	
• In operation	0 to +30 °C
• Storage	-20 to +50 °C
Relative air humidity	0 to 90%
Dimensions (W x H x D) incl. rubber pads	147.5 x 75.5 x 163.5 mm
Weight	1080 g
Charging compartments	8 of which are 4 combined charging compartments for handheld / bodypack devices

Dimensions in mm and [inches]

Power supply unit:

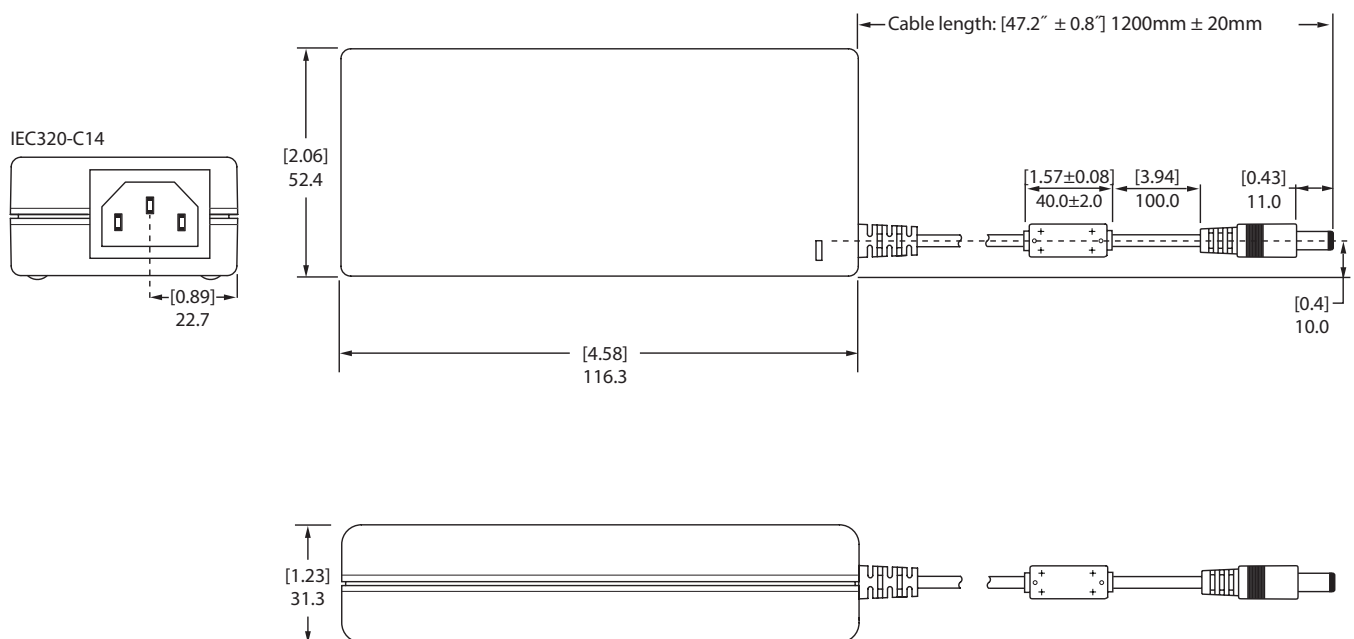

Charger with Unite devices:

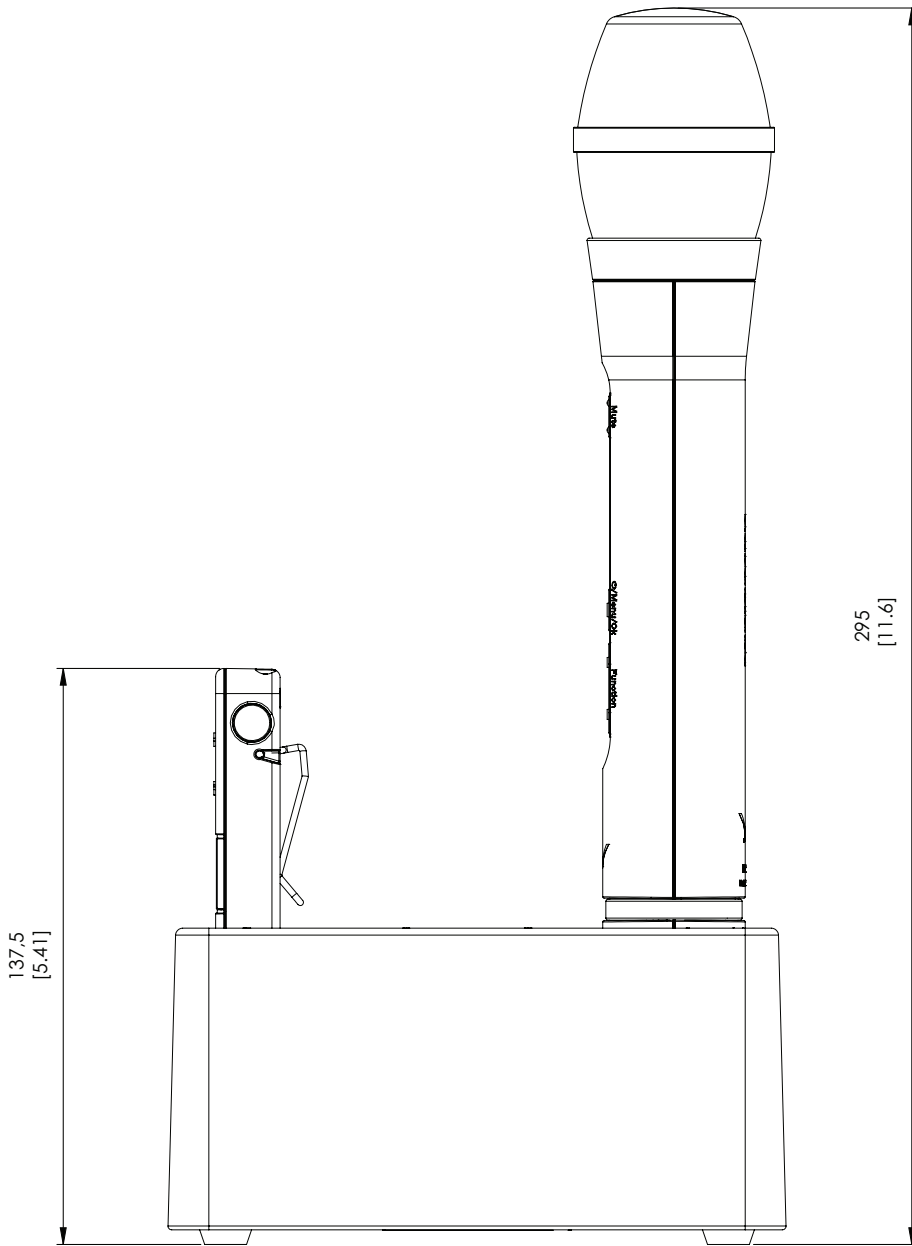

Charger without devices:

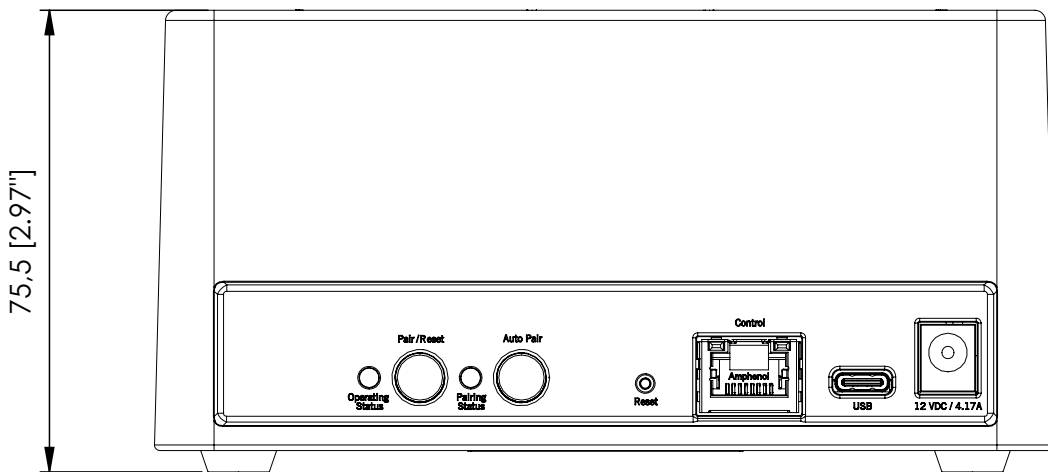
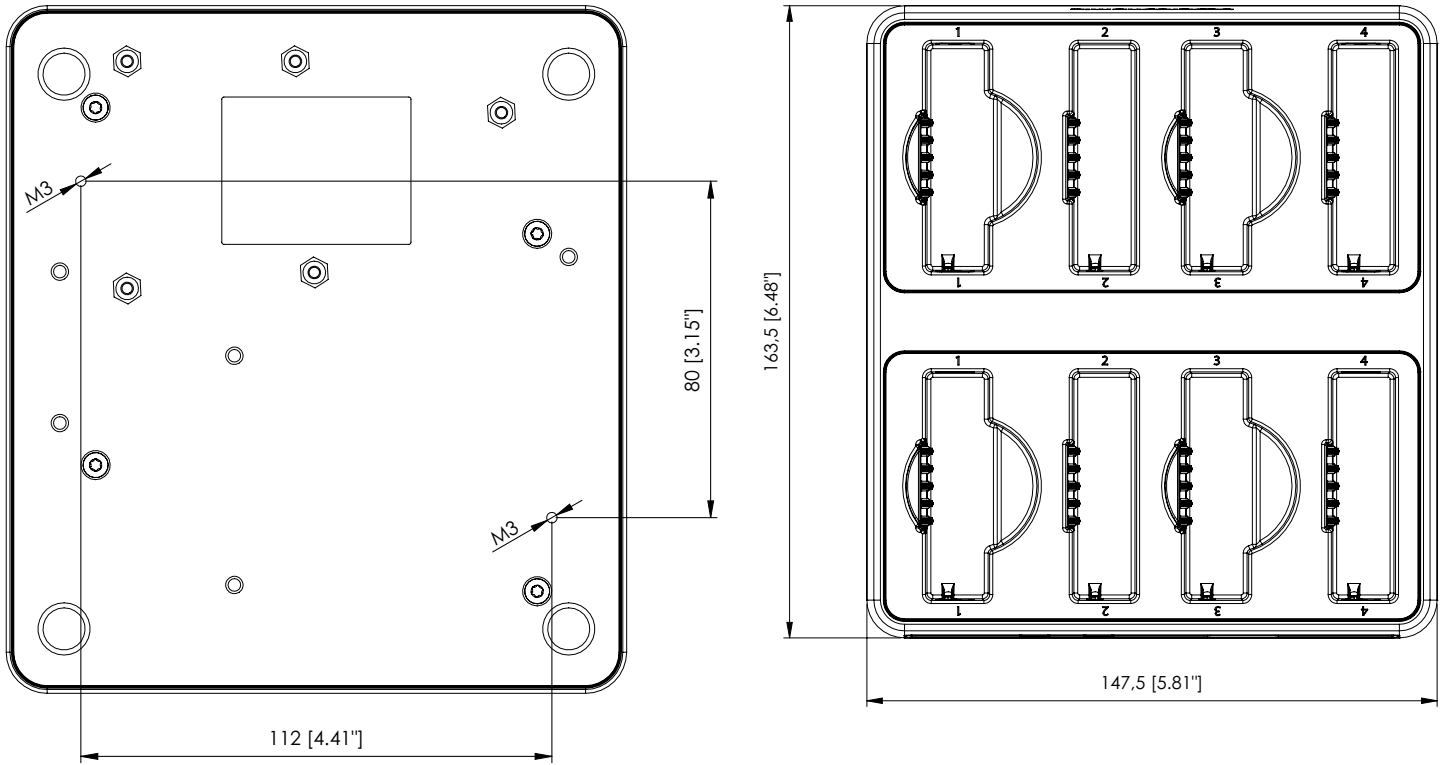

Drilling Template

Bottom view of the device: outer edges are the external dimensions of the charger. The template is rotationally symmetrical. Scale 1 : 1

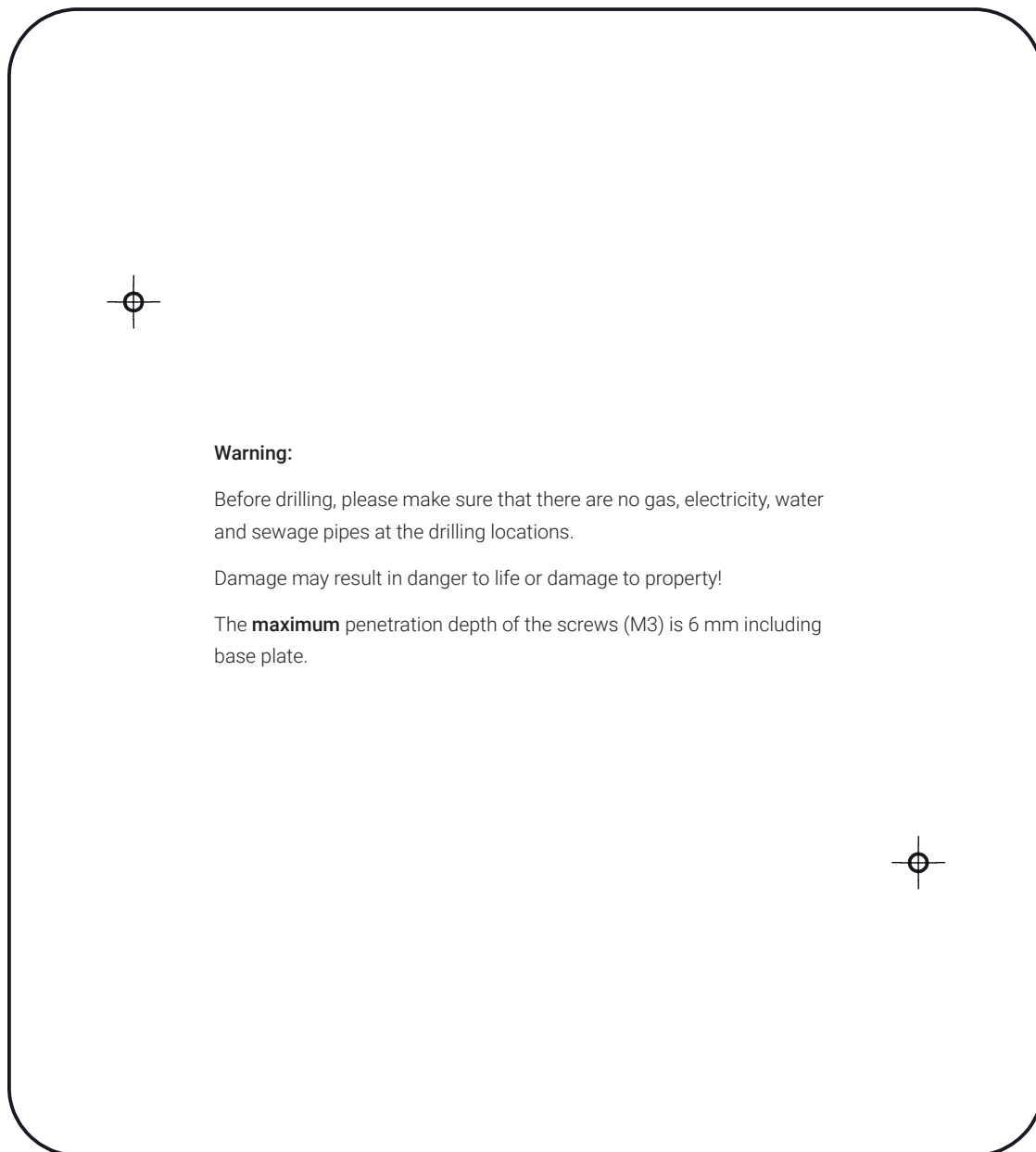

Rear of the device (connections)

Drilling Template

Top view of the device: outer edges are the external dimensions of the charger. The template is rotationally symmetrical. Scale 1 : 1

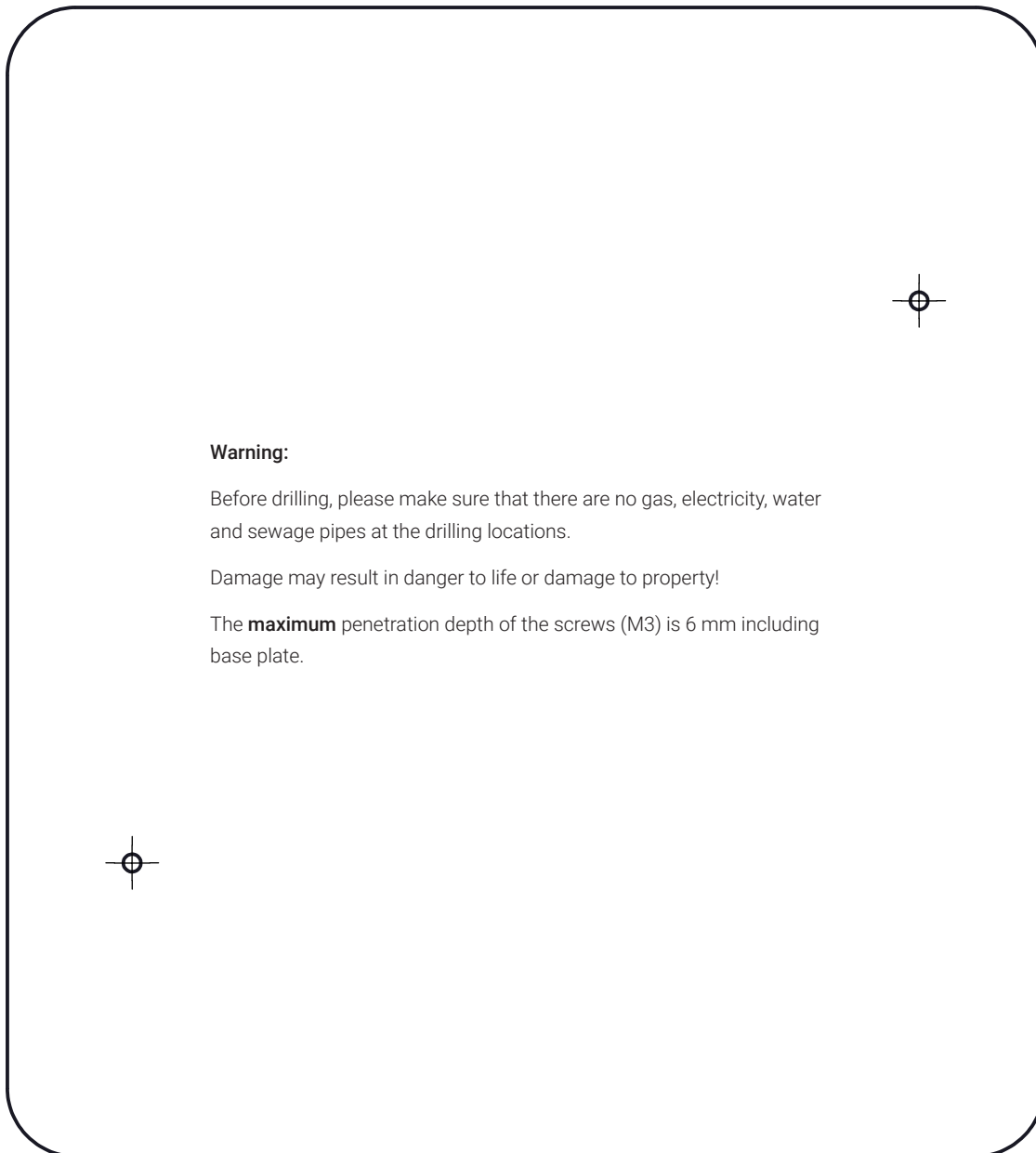

Warning:

Before drilling, please make sure that there are no gas, electricity, water and sewage pipes at the drilling locations.

Damage may result in danger to life or damage to property!

The **maximum** penetration depth of the screws (M3) is 6 mm including base plate.

Rear of the device (connections)

HQ Belgium

+32 51 30 30 45
 conference@televic.com
<https://www.televic.com/en/conference>

Asia

+86 21 61 48 01 23
 conference@televic.com
www.televic-conference.com.cn

France

+33 3 74 09 52 76
 conference-france@televic.com
www.televic-conference.fr

United States

+1 916 920 0901
 conference-us@televic.com

All information copyright Televic Conference, 2023.
 Televic reserves the right to change this document without notice.

Version 1.0